

# 10" Portable DVD Player Model: PDV-1042M



## Operations Manual



# Table Of Contents

<b>Important Safety Instructions</b>	3
<b>Characteristic Features</b>	5
<b>Screen And Main Panel</b>	6
<b>Right and Left Side Panels</b>	7
<b>Remote Control</b>	8
<b>Connections</b>	10
Connecting to External AV Source	10
Connecting to Normal Amplifier	10
<b>Playback Preparations</b>	11
Usage Of Remote Control	11
Disc Formats Supported By This Player	12
Usage Of The Power Adapter	13
Using Headphones	13
<b>Special Features Of Revolving LCD Screen</b>	14
<b>Power Supply</b>	15
About Rechargeable Battery Pack	15
Attaching The Battery Pack	16
Charging The Battery Pack	16
Detaching The Battery Pack	16
Using A Car Adapter	17
<b>Play Operation</b>	18
<b>System Setup</b>	20
<b>Playback Functions</b>	23
<b>Carrying Case</b>	26
<b>Troubleshooting</b>	29
<b>Specifications</b>	30

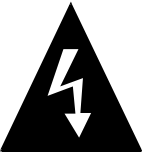
## Important Safety Instructions

	<b>CAUTION</b> <b>RISK OF ELECTRIC SHOCK</b> <b>DO NOT OPEN!</b>	
<b>CAUTION:</b> TO REDUCE THE RISK OF ELECTRIC SHOCK, DO NOT REMOVE COVER (OR BACK). NO USE-SERVICEABLE PARTS INSIDE. REFER SERVICING TO QUALIFIED SERVICE PERSONNEL.		



The lightning flask with arrowhead symbol, within an equilateral triangle, is intended to alert the user to the presence of uninsulated “dangerous voltage” within the product’s enclosure that may be of sufficient magnitude to constitute a risk of electric to persons.



The exclamation point within an equilateral triangle is intended to alert the user to the presence of important operating and maintenance (servicing) instructions in the literature accompanying the appliance.

<b>WARNING:</b> TO REDUCE THE RISK OF FIRE OR ELECTRIC SHOCK, DO NOT EXPOSE THIS APPLIANCE TO RAIN OF MOISTURE.
---

### **POWER SUPPLY:**

Connect the supplied adapter to the side of the DVD player in the slot marked “Power In”. Plug the two-prong end of the power cord to an AC100-240V outlet. If you have difficulty inserting the plug, turn it over and reinsert it, if the unit will not be used for a long time, disconnect the plug from the outlet.

### **NOTE:**

Before plugging the power cord into an AC outlet, make sure that all the connections have been made.

**CAUTION:** These servicing instructions are for use by qualified service personnel only. To reduce the risk of electric shock, do not perform any servicing other than that contained in the operating instructions unless you are qualified to do so. Refer to service manual for servicing instructions.

# Important Safety Instructions

1. Read these instructions.
2. Keep these instructions.
3. Heed all warnings.
4. Follow all instructions.
5. Do not use near water.
6. Clean only with dry cloth.

## **IMPORTANT FOR LASER PRODUCTS**

### **1. CLASS 1 LASER PRODUCT**

2. **DANGER:** Visible laser radiation when open and interlock failed or defeated. Avoid direct exposure to beam.
3. **CAUTION:** Do not open the top cover. There are no user service-able parts inside the unit. Leave all servicing to qualified service personnel. This unit complies with FDA regulation for radiation control of laser products.

7. Do not block any ventilation openings. Maintain well ventilated conditions around the product, Do not put product on bed, sofa or anything that blocks ventilation. Install in accordance with the manufacturer's instructions.
8. Do not install near any heat sources such as radiators, heat registers, stoves, or other apparatus (including amplifiers) that produce heat.
9. Do not defeat the safety purpose of the polarized or grounding-type plug. A polarized plug has two blades with one wider than the other. A grounding type plug has two blades and a third grounding prong. The wide blade or the third prong is provided for your safety. If the provided plug does not fit into your outlet, consult an electrician for replacement of the obsolete outlet.
10. Protect the power cord from being walked on or pinched particularly at plugs, convenience receptacles, and the point where they exit from the apparatus.
11. Only use attachments/accessories specified by the manufacturer.
12. Use only with the cart, stand, tripod, bracket, or table specified by the manufacturer, or sold with the apparatus. When a cart is used, use caution when moving the cart/apparatus combination to avoid injury from tip-over.
13. Unplug this apparatus during lightning storms or when unused for long periods of time.
14. Refer all servicing to qualified service personnel. Servicing is required when the apparatus has been damaged in any way, such as power-supply cord or plug is damaged, liquid has been spilled or objects have fallen into the apparatus, the apparatus has been exposed to rain or moisture, does not operate normally, or has been dropped.
15. Apparatus shall not be exposed to dripping or splashing and no objects filled with liquids, such as vases, shall be placed on the apparatus.

## **Copyright Protection**

Unauthorized copying, broadcasting, public performance, and lending of disks are prohibited. This product incorporates copyright protection technology that is protected by method claims of certain U.S. patents and other intellectual property rights owned by Macrovision Corporation and other rights owners. Use of this copyright protection technology must be authorized by Macrovision Corporation, and is intended for home and other limited viewing uses only unless otherwise authorized by Macrovision Corporation. Reverse engineering or disassembly is prohibited.

# **Characteristic Features**

---

## **Excellent Sound**

Dolby Digital output for excellent sound.

## **High Resolution**

MPEG2 decoding format achieves more than 500 lines of horizontal resolution.

## **Special Functions**

Supports multi-angle view, subtitle caption.

## **Compatibility**

Compatible with DVD, CD, CD-R, CD-RW, MP3 and PICTURE CD discs.

## **Particular Performance**

Multi-speed, fast forward, fast backward, slow play and repeat playback.

## **Search By Time**

Search for a certain time on a disc.

## **Last Memory Playback**

Continues playing from place stopped.

## **AV Input**

External Audio / Video input can be connected to most external AV sources.

## **On-Screen Display**

On-screen displays in your choice of English/Spanish/French.

## **Audio Out**

Audio output terminal for connection to audio amplifiers.

## **Earphone Output**

Convenient for listening to movies or music in private.

## **Amplifier Function**

Built-in 2x1W stereo amplifier and left and right speakers.

## **LCD (Liquid Crystal Display)**

Designed with 10.2" color LCD screen clearly shows the data.

## **Revolving LCD Screen**

Adjust the screen for custom viewing by revolving it horizontally about its axis, or lay it flat with the screen facing up.

## **Switching Power Adapter**

Automatically adapts to voltage required in the U.S. and other European countries.

# Screen and Main Panel

## Unit Drawing

Open the cover of the unit to see the fashionable style of the product:

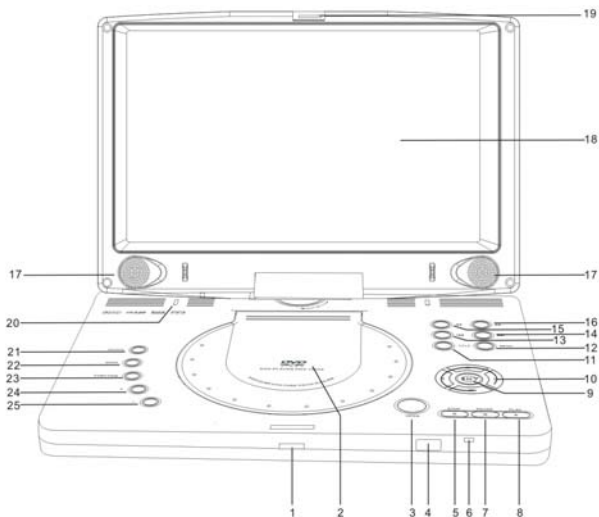

### 1. LCD display fasten

Press to open the LCD screen.

### 2. Disc tray cover

For disc to be put in

### 3. OPEN button

Press to open the disc tray cover.

### 4. Remote sensor

Receive the remote control signal for operation.

### 5. STOP button

Press to stop playback.

### 6. Power on indicator

Lights green when the player is in operation.

Lights red when the player is in standby mode.

### 7. PAUSE button

Press to pause playback.

### 8. PLAY button

### 9. ENT button

Press to confirm selections.

### 10. Direction buttons

Press to select menu items or settings.

### 11. TITLE button

Press to display titles if present on the DVD disc.

### 12. MENU button

Press to display the disc menu on the LCD screen in Play mode.

### 13. ⏮ Prev skip button

Press to skip to previous chapter/track.

### 14. ⏭ Next skip button

Press to skip to next chapter/track.

### 15. ⏪ Reverse scan button

Press to scan reverse.

## DVD Player continued

### 16. ▶ Forward scan button

Press to scan forward.

### 17. Speaker

For enjoying high quality stereo music.

### 18. LCD screen

Present high resolution picture.

### 19. Latch hook

### 20. TFT-Switch button

Press to turn on or off the LCD screen display.

### 21. ROTATE button

Press to rotate the picture up and

down of 180 degree.

### 22. MODE button

Press to change aspect ratio among 4:3,16:9 and zoom modes.

### 23. FUNCTION button

Press to enter the brightness, color or contrast level adjusting mode.

### 24. + button

Press to adjust the brightness, color or contrast level upward.

### 25. - button

Press to adjust the brightness, color or contrast level downward.

## Right and Left Side Panels

### Right Side Panel Drawing

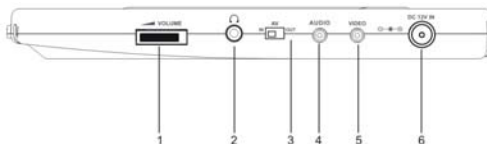

#### 1. Earphone volume adjusting knob

Used to adjust the earphone and speaker volume.

#### 2. Earphone jack

HI-FI earphone output, when connecting this jack, speaker volume is turned off.

#### 3. AV IN/OUT switch

Switch to IN, then the player is in audio and video input mode.

Switch to OUT, then the player is in normal playback mode.

#### 4. Audio input/output jack

#### 5. Video input/output jack

#### 6. Direct current 12V input jack

### Left Side Panel Drawing



#### 1. Earphone jack

#### 2. Power On/Off switch

# Remote Control

---

## The Remote Control

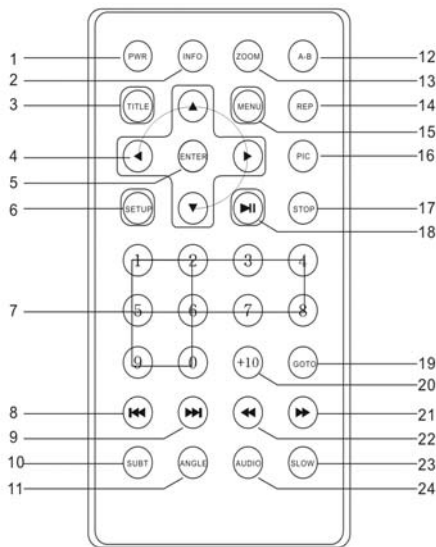

**1. PWR button**

Press to enter standby mode.

**2. INFO button**

Press for detailed information on the disc playing.  
Keep pressing to remove information from screen.

**3. TITLE button**

Press to display titles if present on the disc.

**4. Direction buttons**

Press to select menu items.

**5. ENTER button**

Press to confirm the items or setting.

**6. SETUP button**

Press to access the DVD player's setup menu.

**7. 0-9 number buttons**

Select numbers by pressing these buttons.

**8. ⏮ PREV SKIP button**

Press to go to beginning of current track. Press twice to go to beginning of previous track.



# Remote Control

---

**9. ►► NEXT SKIP button**

Press to go to next chapter.

**10. SUBT button**

When a DVD is playing, press to select a subtitle language or to turn subtitles off, if the DVD disc contains multiple subtitles.

**11. ANGLE button**

Press to access various camera angles, if the DVD disc contains multiple camera angles.

**12. A-B button**

Press to mark a segment to repeat between A and B.

**13. ZOOM button**

Press to cycle through zoom function.

**14. REP button**

Press to repeat a chapter, track, title, or all content.

**15. MENU button**

Press to enter disc menu.

**16. PIC button**

Press to enter the brightness, color or contrast level adjusting mode.

**17. STOP button**

Press once to stop playback and then press the PLAY button to resume normal playback. Press the button twice to stop playback completely.

**18. Play/Pause button**

Press to start or pause playback.

**19. GOTO button**

Press to select the desired disc starting time, track or title.

**20. +10 button**

Select numbers greater than 9 by pressing the (+10) button first, and then an additional number button.

**21. ►► FWD SCAN button**

Press to search forward.

**22. ◀◀ REV SCAN button**

Press to search backward.

**23. SLOW button**

Press to activate slow forward or slow rewind.

**24. AUDIO button**

Press to access various audio languages, if the DVD disc contains multiple audio languages.

# Connections

---

## Connecting to External AV Source

### Audio/Video Connections

Always ensure that the DVD player, TV and any other electrical equipment you are connecting the DVD player to is switched off and unplugged from the power supply. The easiest way to connect the DVD player to a television is via the supplied Audio/Video connections. Connect the audio/video cable from the DVD player to the TV's audio/video inputs.

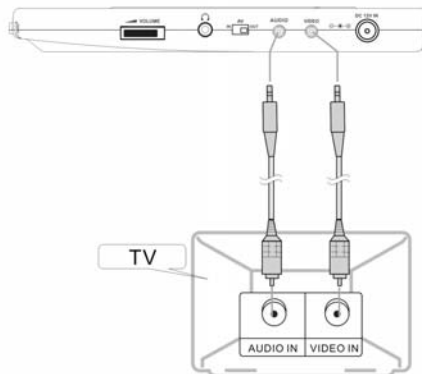

## Connecting To Normal Amplifier

The DVD player can be connected to a normal amplifier. Please refer to your Audio equipment's manual before connecting.

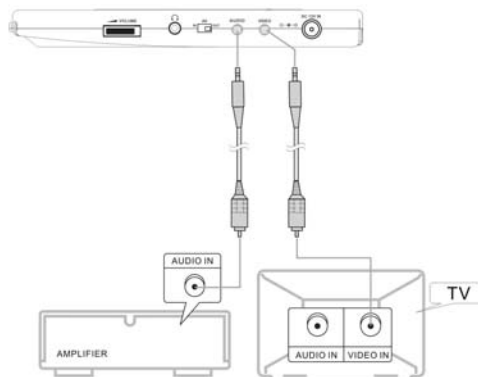



# Playback Preparations

---

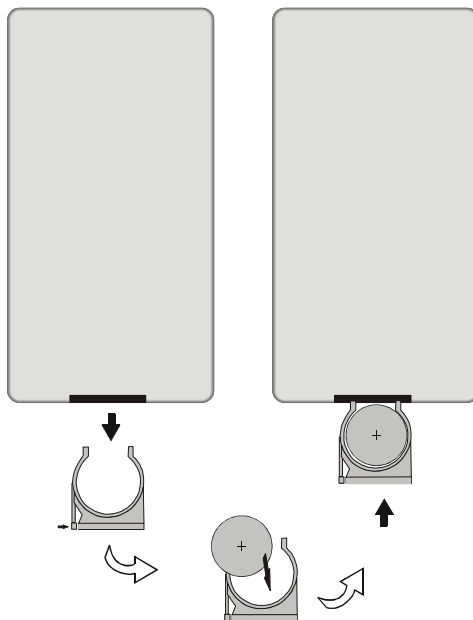

## Usage of Remote Control



1. Refer to the drawing of the back of the remote control and remove the empty battery receptacle.
2. Prior to shipping, a separating film was applied to the battery. Remove this film.
3. Insert the battery into the receptacle and insert the receptacle into the remote.
4. For best results, aim the remote directly at the player's receiving window within the range of 15 feet, and angles of 60 degrees.
5. Under normal use the battery will last for one year.
6. Remove battery if the device is not to be used for a long time during storage.

# Playback Preparations

## Disc Formats Supported by this Player

	DISC LOGO	DIAMETER	PLAYBACK TIME/ PLAYABLE SIDES
DVD		12cm	133 min (SS-SL)
			242 min (SS-DL)
			266 min (DS-SL)
			484 min (DS-DL)
		8cm	41 min (SS-SL)
			75 min (SS-DL)
			82 min (DS-SL)
			150 min (DS-DL)
CD		12cm	74 min
		8cm	20 min
MP3		12cm	600 min

The operating method of some DVD discs is specified by the software maker. Please refer to the instruction manual of the disc.

### Care of Discs

Do not touch the playing surface of the compact disc.

Do not stick paper and label on the disc.



### Cleaning of Discs

If a disc has fingerprints or dust on it, lightly wipe the disc with soft cloth (or similar) from the center of the disc outward in a radial manner.



### Storage of Discs

Do not expose discs to direct sunlight.

Do not place discs near water or in dusty place.

Never use record cleaning sprays, benzene, thinner, static electricity prevention liquids or any other solvents to clean your discs.

# Playback Preparations

---

## Usage of The Power Adapter

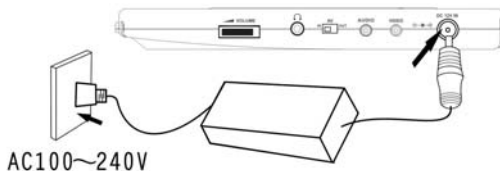

**Note:** Please turn player's power off first and then unplug the power to prevent malfunction.

### **Usage of Adapter**

The player is supplied with a switching power adapter.

1. Connect AC adaptor to the side of the DVD player in the slot.
2. Connect the rabbit joint end of the AC adaptor to the power cord.
3. Plug the two-prong end of the power cord to a grounded electrical socket.

### **Pre-operation**

1. Connecting to power.
2. Switch "POWER" to the "ON" position.
3. Lift the main cover up to open the disc tray house.
4. Press the OPEN button to open the disc cover.
5. Put disc into the tray house with the printed side upward.
6. Close the disc cover.
7. Adjust the volume with the "VOLUME" adjusting knob (also adjusts earphone volume).

## Using Headphones

See the right picture, connect Headphone plug into the Headphone Jack on the right side of the unit

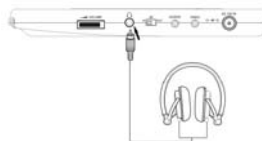

### **Quick Tips**

- Excessive loud usage of headphones could damage your hearing.
- Turn down the Volume before you connect the headphones, and then raise the volume to suit your level.
- Sound from the external speaker will cease when headphones are connected.

# Special Features of Revolving LCD Screen

The revolving LCD screen is one of the outstanding features of this product. For proper operation, follow these steps.

Pos A



1. Open the screen cover to position (A) as shown in the left figure so the screen is vertical to the operation panel.

Pos B



2. Rotate the screen horizontally about its axis only in the clockwise direction. The maximum rotation is 180 degrees (position C) at which you will hear a click and the screen faces backward. If you want to return to the initial position (A) rotate the screen counter clockwise until it clicks.

Pos C



3. You can tilt the screen vertically from position C to the operation panel as indicated in the left figure.

Pos D

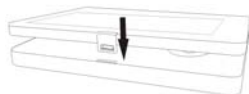

4. At the final position (position D) the screen faces upward, with its back to the operation panel.



5. Your Portable DVD Player includes a sturdy carrying bag/mount for the ultimate in portable convenience! The bag/mount is easy to attach and fits on nearly any car or truck seat.

# **Power Supply**

---

## **About Rechargeable Battery Pack**

Your portable DVD player comes with a lithium ion rechargeable battery that attaches to the bottom of the player. Your new battery should be fully charged before it is used for the first time. Charging time is normally about 5 hours. A fully charged battery delivers about 3 hours of use, but playing time varies from disc to disc. We recommend you only charge the battery when the battery is down to its last hour of charge or completely out of power. Unnecessary charging of the Battery Pack will reduce service life. If the battery is not used it will automatically discharge gradually within one month.

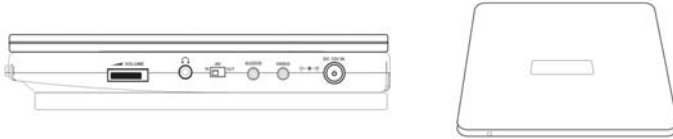

If you don't plan on using the battery for an extended period of time, discharge the battery and keep it in a dry and cool place.

If the battery loses power during play, stop playing the DVD, otherwise damage may occur.

## **Working conditions and precautions for the battery**

- New batteries should be fully charged before initial use.
- Battery should only be used and charged when temperatures are between 32-95F.
- Never put the battery in fire or water.
- Do not expose the battery to high temperatures or store in hot, sunny places.
- Maintain well-ventilated conditions around the product, avoiding heat. Don't put the product on bed, sofa or anything that may block ventilation to the product.
- Don't use metal to link positive pole to negative.
- Do not open the battery.
- Do not leave battery attached when using alternative power source.
- Never charge the battery for more than 8 hours. Detach battery immediately after charging is complete. When charging the battery pack, the light on the battery will turn red, when the charging is complete, the light will turn green.
- Detach battery when not in use.



# Power Supply

## Attaching The Battery Pack

The player's power is supplied via the switching power adapter or the battery pack, which are provided with the player. Steps for connecting the battery pack to the player are as follows:

### **Attaching the Battery Pack**

Turn the player upside down on a smooth, clean surface. Direct the battery so that the battery contacts and the five plastic tabs are aligned with the matching contacts and tab recesses on the player.

### **Lock the Battery Pack**

With one hand on the player to prevent it from moving, push the battery pack on to the player then slide the Battery Pack toward the front of the Player until you hear it click and lock into place.

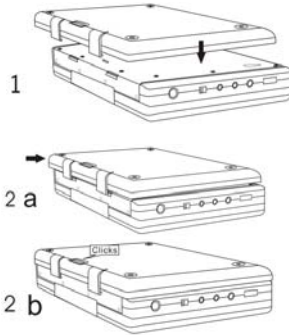

## Charging The Battery Pack

Plug the Power Adapter into the Player's DC-IN 12 V Jack, which is located on Right Side of the player, and then plug the other end of the Power Cord into a household wall Power Outlet.

See the right figure.

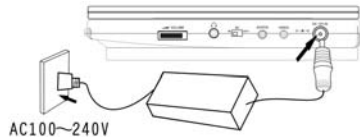

## Detaching The Battery Pack

If the player is not going to be used for a long period of time, we recommend that you detach the Battery Pack. Even if the unit is powered down, the unit is still consuming some power in STANDBY mode. This could lead to discharging the battery.

Make sure the power is turned off before detaching the Battery Pack. After detaching the battery pack, take care when handling the unit.

1. Hold player in position so it doesn't slide.

Press the tab towards the front of the unit and hold it in the position.

2. Taking off the Battery Pack

Gently slide the Battery Pack toward the back of the Unit. Carefully lift the Battery Pack from your player.

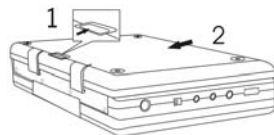

# Power Supply

---

## Using a Car Adapter

You can use Car Adapter while in a vehicle:

Connecting the Car Adapter Power Plug into the unit's Power Jack and the other end to the Vehicle Cigarette Lighter socket as shown.

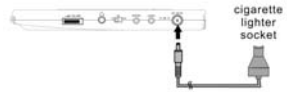

### Quick Tips

- Do not operate the unit or view video while driving a vehicle.
- Place the unit in a secure position for viewing.
- Do not leave battery attached when using car adaptor as a power source.

# Play Operation

---

Please read these instructions carefully before using your DVD player for the first time.

1. Turn on the player's power by switching the POWER switch on the side of the player to "ON".
2. Press OPEN button on front panel to open the disc cover.
3. Load disc with the label facing up to prevent damage to the player or disc.
4. Close the disc cover. The player will automatically search for the disc and when it finds it, play will begin.

**Warning:** Do not play poor quality discs to prevent damage to the lens.

## Start Playback

1. Press the Play/Pause button on the remote control once.
2. Press ◀ ▶ (direction button) or the number buttons to select a scene.
3. Press the ENTER or Play/Pause button to start playback.

## Pause

1. Press the Play/Pause button on remote **once** to pause.
2. Press the Play/Pause button again to resume normal playback.

## Zoom

1. Press the ZOOM button on the remote to cycle through different zoom settings.
2. Normal – 2x – 3x – 4x – 1/2 – 1/3 – 1/4.
3. While in zoom mode use the direction keys to move around to different positions on the picture.

# Play Operation

---

---

## Stop

1. During playback, press the STOP button once on the remote control to stop playing.
2. Press the Play/Pause button, and then the player will play from the point where it stopped.

## Mode

During playback, press the MODE button on the control panel to change the aspect ratio on the screen.

## Rotate

During playback, press the ROTATE button on the control panel to rotate the picture displayed up and down of 180 degree.

## Title Menu

1. Press the TITLE button on the remote control during playback. The title menu will appear on the LCD screen.
2. Press ◀ ▶ ▲ ▼ (direction button) or the number buttons to select the title or disc option you wish to play.
3. Press the ENTER button to start playback.

**Note:** Title and Menu are only available for DVD discs.

## Previous and Next

1. Press the PREV button twice on the remote control, and playback will start from the previous track.
2. Press the NEXT button on the remote control, and playback will start from the next track.

# System Setup

---

You can change the default settings to customize performance to your own preference.

Remove the disc from the disc tray and press the 'SETUP' button on the remote control, the settings menu will appear. It includes General Setup, Speaker Setup, Dolby Digital Setup, Video Setup and Preference setup.

Press the ◀ ▶ ▲ ▼ ▶ (direction buttons) on the remote control to select a category. All the items in the category will appear on the TV screen. Press the 'ENTER' button to confirm your selection.

## **Category**

When you enter a category all the items under this category will appear, and the items placed in the middle (or highlighted) will be the current set up.

Press the ▶ (right direction button) on the remote control to select the correct category.

Press the direction buttons to select your preference. The item you select will be highlighted.

Press the 'ENTER' button for confirmation.

Press the ◀ (left direction button) to enter the other setup menu.

## **General Setup**

### **TV Display**

Select Normal/PS or Normal/LB when a 4:3 TV is connected.

In Normal/LB mode, the displayed images are marked with bars above and below the picture. In Normal/PS mode, the displayed images will be cut off.

Select Wide when a 16:9 wide screen TV is connected.

### **Angle Mark**

If the scene was shot from multiple angles, then you can easily change the camera angle of the scene you are watching.

ON/OFF

With this switched on you will be notified if alternative viewing angles are available.

### **OSD Lang**

There are several different OSD languages (subtitles) for selection. You can select it according to your preference.

# **System Setup**

---

---

## **Captions**

You can choose captions on or off on screen during playback.

## **Screen Saver**

When activated, the screen saver automatically works if there has been no operation for a period of time.

## **Last Memory**

You can set the function on or off. Select on, it will start playing from the stop point. Select off to disable the function.

## **Speaker Setup**

### **Downmix**

Select "LT/RT" in DOWNMIX, then the player will output mixed in a Dolby stereo output. Select "Stereo" and the player will output a standard stereo signal.

## **Dolby Digital Setup**

### **Dual Mono**

The function is used to set the output mode of channel left/right, stereo and mixed sound.

### **Dynamic**

Use this item to adjust linear dynamic compression rate to get different signal compression effects.

## **Video Setup**

### **Sharpness**

Use this item to adjust sharpness level.

### **Brightness**

Use this item to adjust brightness level.

### **Contrast**

Use this item to adjust contrast level.

# System Setup

---

---

## **Preference Page**

### **Audio, Subtitle, Disc Menu**

This setting allows you to hear or read subtitles of a DVD in your choice of English, Spanish or French etc.

### **Default Reset**

Use this function to reset all the settings.

**Note:** This menu function is not available while a disc is playing.

## **Audio**

DVD discs contain up to 8 audio bit streams. For Example: English, French etc.

To select the audio bit stream you prefer press the AUDIO button on the remote control during playback. The DVD player will play the next audio bit stream every time you press the AUDIO button in succession.

**Note:** This function is only available for discs that have several audio bit streams.

# Playback Functions

---

## Fast Forward & Rewind

Press the ◀ and ▶ buttons to active fast forward or rewind.

## Slow Forward & Rewind

Press the SLOW button to slow forward or rewind.

## Repeat

Repeat a title, chapter or track. Press the REP button on the remote control. Continually pressing the REP button will display a menu as follows: **Chapter, Title, All.**

You can temporarily mark your own section of a DVD that you would like to play repeatedly. You do this by marking the start and the end of the section using the A/B button. During playback press the A-B button on the remote control at the beginning of the segment (point A) you wish to play repeatedly. Press the A-B button again at the end of the segment (point B).

The DVD player will automatically return to point A and repeat playback of the selected segment (A-B). To resume normal playback, press the A-B button again.

## Subtitle

A DVD disc can be recorded with up to 32 subtitles.

Press the SUBT button on the remote control, the mode of subtitles will recycle as follows: SUBTITLE 1/N: Subtitle 1 appears on the screen. SUBTITLE 2/N: Subtitle 2 appears on the screen.

SUBTITLE N/N: Subtitle N (N is the total number of subtitles that the current disc contains) appears on the screen. SUBTITLE OFF: No subtitle.

**Note:** This function is only available on DVD disc that were recorded with multiple subtitles.

## Angle

If the scene was recorded from multiple angles, you can easily change the camera angle of the scene you are watching.

Press the ANGLE button on the remote control during playback. Playback will shift to another angle. If the disc menu gives the options of angles items, you can switch angles for viewing by pressing the number buttons on the remote control.

**Note:** This function is only available if a disc is a multi-angles recorded disc.



# Playback Functions

---

## Search by time

During DVD disc playback, press the GOTO button on the remote control once, there will be a menu displayed on the screen. You can set or select items for your preference. Use the ▲ ▼ direction buttons to select items, press the ENTER button to enter and use the ▲ ▼ direction buttons to select the desired item. Press the ◀ direction button to return. When select the Title or Chapter, use number buttons to input desired title or chapter.

## Resume Playback

Press the STOP button at the location if you wish to interrupt playback. The player memorizes the location where playback was stopped.

Press the Play/Pause button to resume normal playback. The player resumes playback from the location where you stopped playback. This function does not operate if the disc is removed.

Press the STOP button twice or open the disc tray, playback will then be stop and when the Play/Pause is pressed, the play will begin from the beginning of disc.

## Playing an MP3

MP3 is the third audio compression format of international standard MPEG, which compresses the audio signal at the rate of 12:1. Using MP3 format, one disc can record more than 600 minutes music, the sound quality is similar to that of CD discs.

There are many different formats for storing MP3 songs. Usually, one MP3 disc includes many folders (directories) and every folder includes several files (songs). In stop status, press the up/down direction button to select the directory as you desire and press the ENTER or Play/Pause button for confirmation, use the up/down direction buttons again to select the desired track.

- During MP3 playback, press the previous or next skip button to turn the page.
- There is no search by time and slow playback function for MP3 discs.

# Playback Functions

---

## Playing a JPEG

JPEG is a common picture format that has few bytes and low loss rate of picture. Hundreds of pictures can be stored on a disc in this format.

## Normal Playback

Load a JPEG disc in. After reading the disc, the OSD will display the menu. Use the direction buttons and ENTER button to choose items.

- Many discs have other items besides pictures.

## Picture Rotation

Picture rotation can be operated while the picture is displayed. When another picture is selected, the rotating function will turn off.

There are four kinds of rotational modes, you can use direction button to choose:

LEFT	Inversion/Normal
RIGHT	Enantiomorphism/Normal
UP	Rotate up
DOWN	Rotate down

## Zoom of Picture

ZOOM button is used to turn the zoom and move function on/off.

As the zoom function is turned on, use the fast forward or reverse scan button to display relevant zoom proportion. Use the direction buttons to change and enlarge the point of the picture ratio.

When zoom function is not available, the picture will display normally. Press the MENU button to return to the menu.

Press the STOP button once to activate preview mode.

Note:

Due to different production methods, some JPEG discs can only be played normally with no rotate or zoom functions.

# Carrying Case

## INSTRUCTIONS FOR ATTACHING YOUR PORTABLE DVD PLAYER CASE IN A VEHICLE

Please read and follow these instructions carefully when attaching this case inside your vehicle. For ease of installation, do not place the DVD player into the case until after the case is attached inside the vehicle.

### CAUTION

1. Do not use this DVD Player Case as a swing, car seat, or for any other purpose except to hold a DVD player and accessories.
2. The DVD Player Case is intended for viewing only from the rear seats. Do not install or use this product in the front seat of a vehicle.
3. To reduce the chance of injury in case of collision or a sudden stop:
  - Always keep the DVD player strapped securely inside its case while the vehicle is moving
  - Always keep the DVD player Case securely attached inside the vehicle while the vehicle is moving

Your DVD player can be securely attached in one of the following ways to view movies from the rear seats:

1. Directly behind either the driver or the passenger seat
2. Between two front bucket seats

### **CAUTION**

Always position the plastic hooks and strap adjustment slider so that they do not contact the back of the head of the person in the front seat.

### **Attach the DVD Player Case to a seat back (Photos 1 & 2):**

1. Unzip the main compartment that holds the player; locate the set of rings tucked inside the top edge of the case (A)
2. Locate the 2 straps with hooks on each end
3. Hook one end of each strap to the rings at the top of the case (A)
4. Criss-cross the straps around the front of the headrest (B) and hook the straps to a second set of rings on the lower part of the case (C)
5. Tighten up the straps until secured

Photo 1



Photo 2

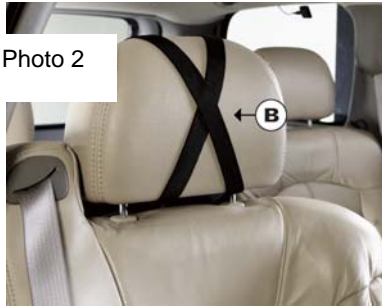

### Suspend the DVD Player Case between 2 bucket seats (Photo 3):

1. Unzip the main compartment that holds the player; locate the set of rings tucked inside the top edge of the case (A)
2. Locate the 2 straps with hooks on each end
3. Hook one end of each strap to the rings at the top of the case (A)
4. Wrap each strap around the headrest or seat; hook the straps to a second set of rings on the lower part of the case (C); in some vehicles, the middle rings in the gusset might work best (D)
5. Tighten up the straps until secured



# Troubleshooting

Symptom	What To Check
The player doesn't play.	<ul style="list-style-type: none"> <li>• Make sure the AV IN/OUT switch on the side of the player unit is in the OUT position for standard play.</li> <li>• Make sure the disc cover is closed.</li> <li>• Make sure a disc is loaded.</li> <li>• Make sure the disc isn't loaded upside down.</li> <li>• Disc should be clean, not dirty or warped.</li> <li>• Player's region code should be the same as region code of DVD disc.</li> <li>• Has water condensation has occurred? If it has, remove the disc and keep the player powered up for at least two hours.</li> </ul>
There is no sound.	<ul style="list-style-type: none"> <li>• Make sure system connection is correct.</li> <li>• Make sure the speakers are turned on.</li> <li>• <b>Make sure the sound setup of DVD disc is correct.</b></li> <li>• Is your disc dirty or warped? Clean or replace disc.</li> </ul>
There is no picture.	<ul style="list-style-type: none"> <li>• Make sure TV is on and in correct video mode.</li> <li>• Make sure your system connection is correct.</li> </ul>
Poor AV performance.	<ul style="list-style-type: none"> <li>• Is your disc dirty or warped? Clean or replace disc.</li> </ul>
Cannot continue to play and play a section repeatedly.	<ul style="list-style-type: none"> <li>• Make sure the player is not in A-B repeat status.</li> <li>• <b>Press A-B button to cancel A-B repeat status.</b></li> <li>• Is your disc dirty or warped? Clean or replace disc.</li> </ul>
The remote control does not work.	<ul style="list-style-type: none"> <li>• Make sure there aren't any obstructions between the remote control and the player.</li> <li>• Make sure you are pointing the remote control at the player.</li> <li>• Make sure batteries are inserted correctly (check polarity).</li> <li>• Replace weak batteries.</li> </ul>

**WARNING:** Do not touch any metal objects to the battery connectors, as it will put the battery in standby mode. To get out of standby mode please connect the battery and portable DVD player to AC or DC power.

## Other possibilities:

Static or other external interfere may cause the player to function abnormally. In this case unplug the power-supply cord from the outlet and plug it in again to reset the player so that normal operation can resume. If you are still having problems, disconnect the power and consult a qualified technician.

# Specifications

LCD screen size		10.2 inches
Laser Wavelength		Wavelength: 780/650nm
Video System		NTSC
Frequency Response		20Hz - 20KHz $\pm 2.5$ dB
Audio Signal-to-noise Rate		$\geq 85$ dB
Audio distortion + noise		$\leq -70$ dB (1KHz)
Channel Separation		$\geq 70$ dB (1KHz)
Dynamic Range		$\geq 80$ dB (1KHz)
Audio Out	Digital Audio Out	Out Level: $1.5V \pm \begin{matrix} 0.2 \\ 1.0 \end{matrix}$ , Load: 10K $\Omega$
Video Out	Video Out	Out Level: $1V_{P-P} \pm 0.2$ , Load: 75 $\Omega$ Unbalanced Negative
Power	AC100-240V - 50/60Hz	
Power Consumption	< 25W	
Dimension w (o) battery	267mm $\times$ 175mm $\times$ 45 (33) mm (L/W/H)	
Weight w/o battery	0.95 kg	
Compliance with FCC, FDA - cUL listed E209155		

**DESIGN AND SPECIFICATIONS ARE SUBJECT TO CHANGE WITHOUT NOTICE**

Manufactured under license from Dolby Laboratories.  
 “Dolby” and the double-D symbol are trademarks of Dolby Laboratories.  
 Confidential unpublished works. © 1992 -1997 Dolby Laboratories.  
 All rights reserved.

For service, support and warranty information, visit [www.polaroidelectronics.com](http://www.polaroidelectronics.com) or in the US call 1-866-289-5168, in Canada call 1-866-301-7922 and in Mexico call 01-800-400-2443.

“Polaroid” is a registered trademark of Polaroid Corporation of Waltham, MA USA and licensed for use on the PDV-1042M to Petters Consumer Brands, LLC.